

fr/Powerboard-OktoXL

1

LotharF
MikroKopter.de

This page as an **PDF-Document**? Click on that Symbol and wait a little moment... --->

OktoXL-Powerboard

-  [english](#)
-  [deutsch](#)

 **Attention:** The XL powerboards are designed for the **BL-Ctrl2.0!** Do **not** use BL-Ctrl1.2 on it.

Inhaltsverzeichnis

1. [Info](#)
2. [OktoXL Power-Distribution](#)
 1. [Arrangement of the BL controller](#)
 2. [Assembly of the Molex connector](#)
 3. [Solder heat conductor](#)
 4. [soldering the Capacitors on the BL-Ctrl2.0](#)
 5. [soldering the BL-Ctrl2.0 on the Power Distribution](#)
 6. [Address selection](#)
3. [Powerboard](#)
 1. [Power Distributor - Top](#)
 2. [Power Distributor - Bottom](#)
 3. [Supply](#)
 4. [Connect the Buzzer](#)
 5. [Lighting](#)
 1. [Lighting switchable](#)
 6. [connect the FC](#)

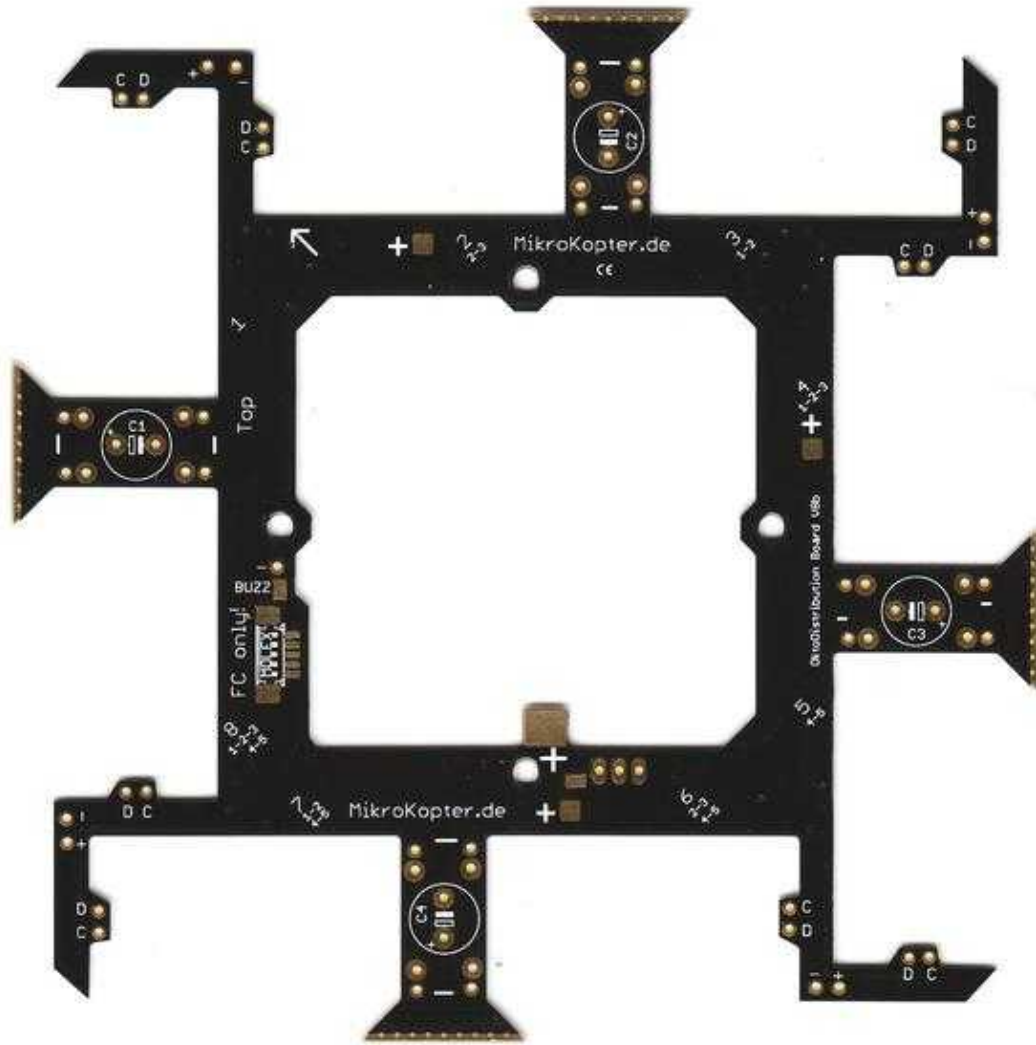

Info

At this current distribution of the BL-Ctrl2.0 overlapping be soldered to the power distribution board. This provides better heat dissipation is possible.

Since the PCB during soldering and the heat dissipates very quickly, you need a soldering iron with enough power (~ 80W). A completely clean soldering is a must.

OktoXL Power-Distribution

The OktoXL Power distributor provides the BL controller with power and connecting the I2C bus for communication.

The BL controllers are mounted in the recesses of the distribution board and connected by wire bonds.

⚠ The top of the distribution board is marked with "+".

Arrangement of the BL controller

The BL-controllers are arranged as shown here in the distribution board (clockwise BL-Ctrl Nr. 1-2-3-4-5-6-7-8).

⚠ The processors and the solder connections for the motor have to show up at all controllers.

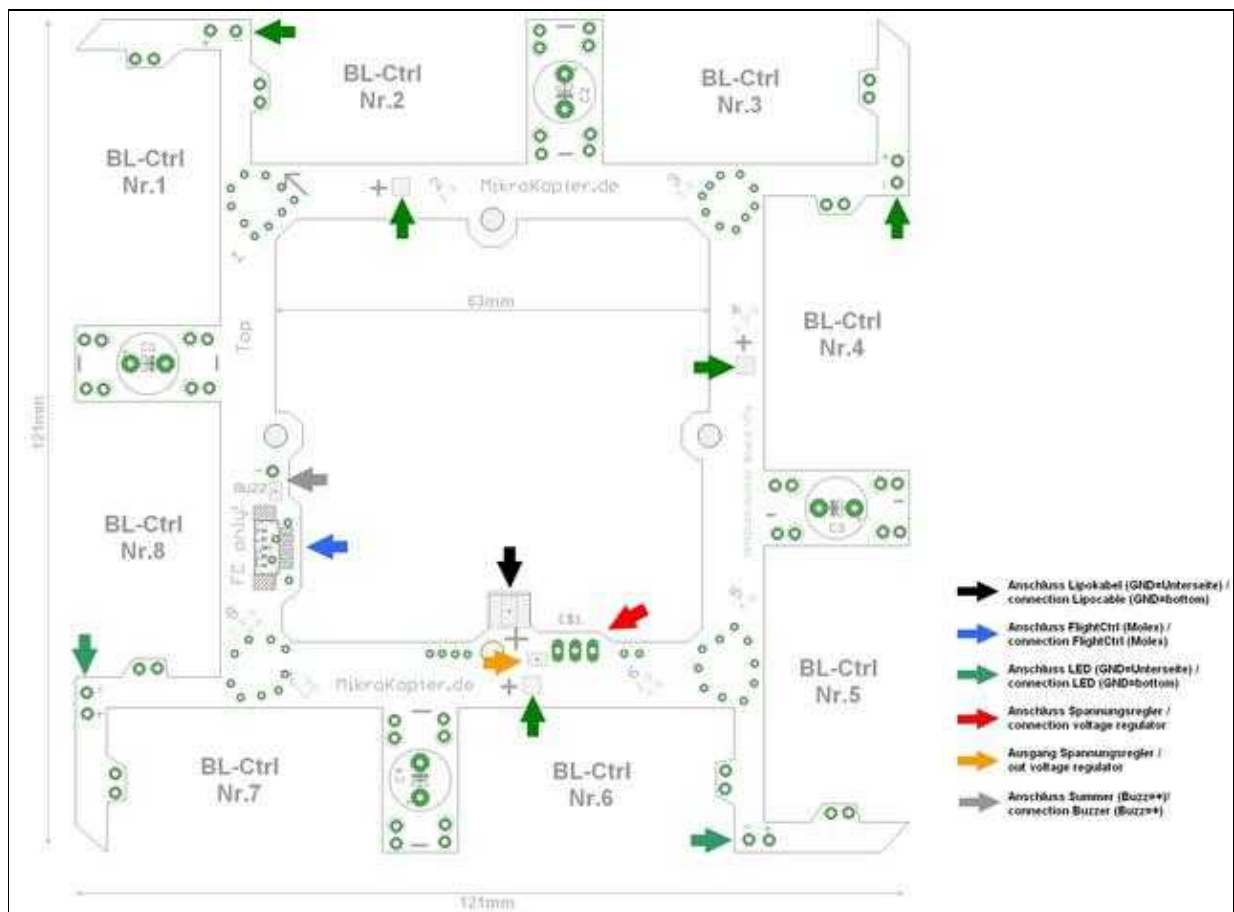

Graphic with BL-Ctrl and dimensions: [OktoXL](#)

i If you use a 5S/6S Lipo on this Power-Distribution and you've got sporadic I2C errors, you can use on C1,C2,C3,C4 a Elko with 330 μ F/25V. Otherwise a placement is not required!

Assembly of the Molex connector

For this purpose you should use a fine tip. The first one is a solder pad on the distribution board and solder then Molexbuchse fixed thereto. This is to cater to the remaining contacts are soldered.

⚠ The contacts may have no connection with each other!

- The [FlightCtrl](#) is connected over the Molex socket with power, I2C-bus and the Buzzer.

i Tip: Excess solder can be removed perfectly with solder wick. If the mounting of the Molex socket fails, the PCB can be gently heated from the bottom with a heat gun and the socket be released.

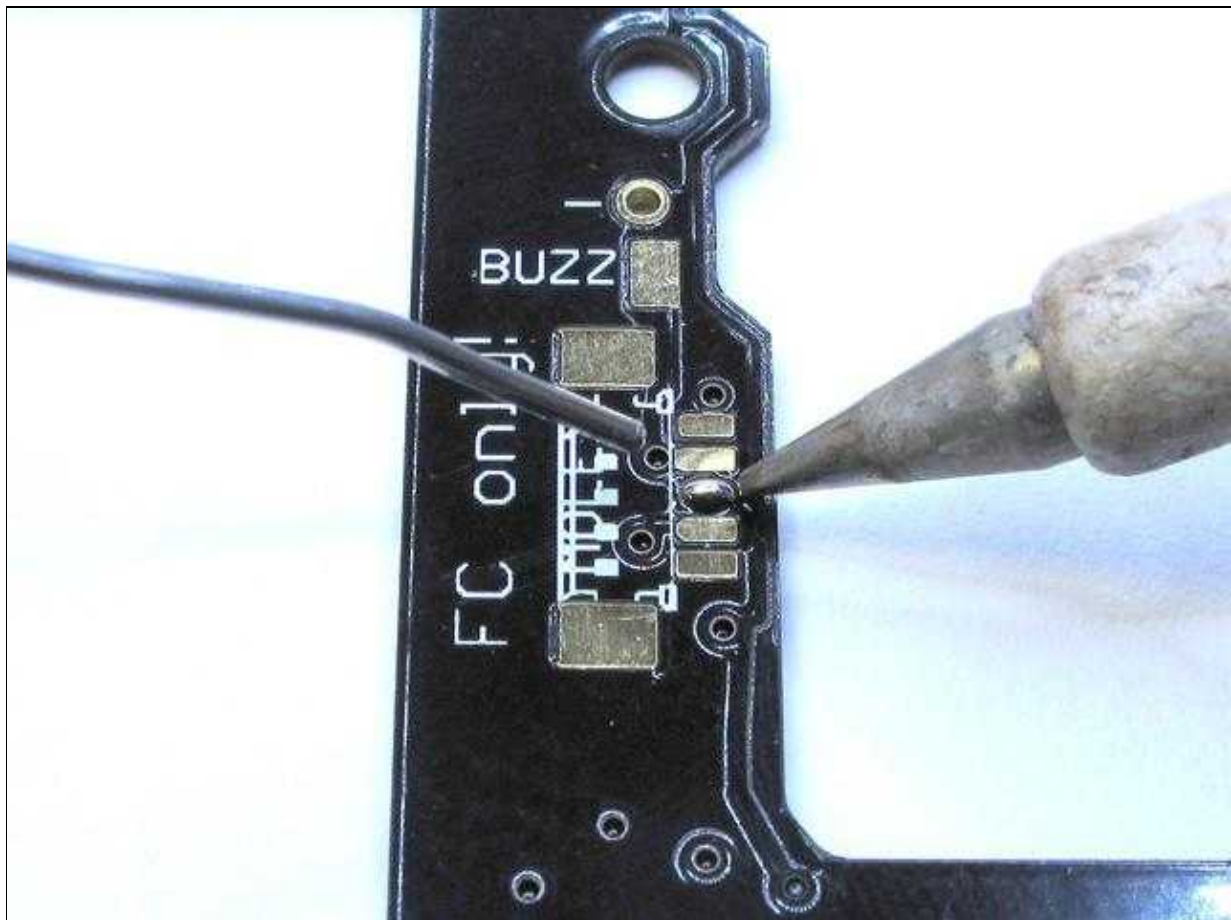

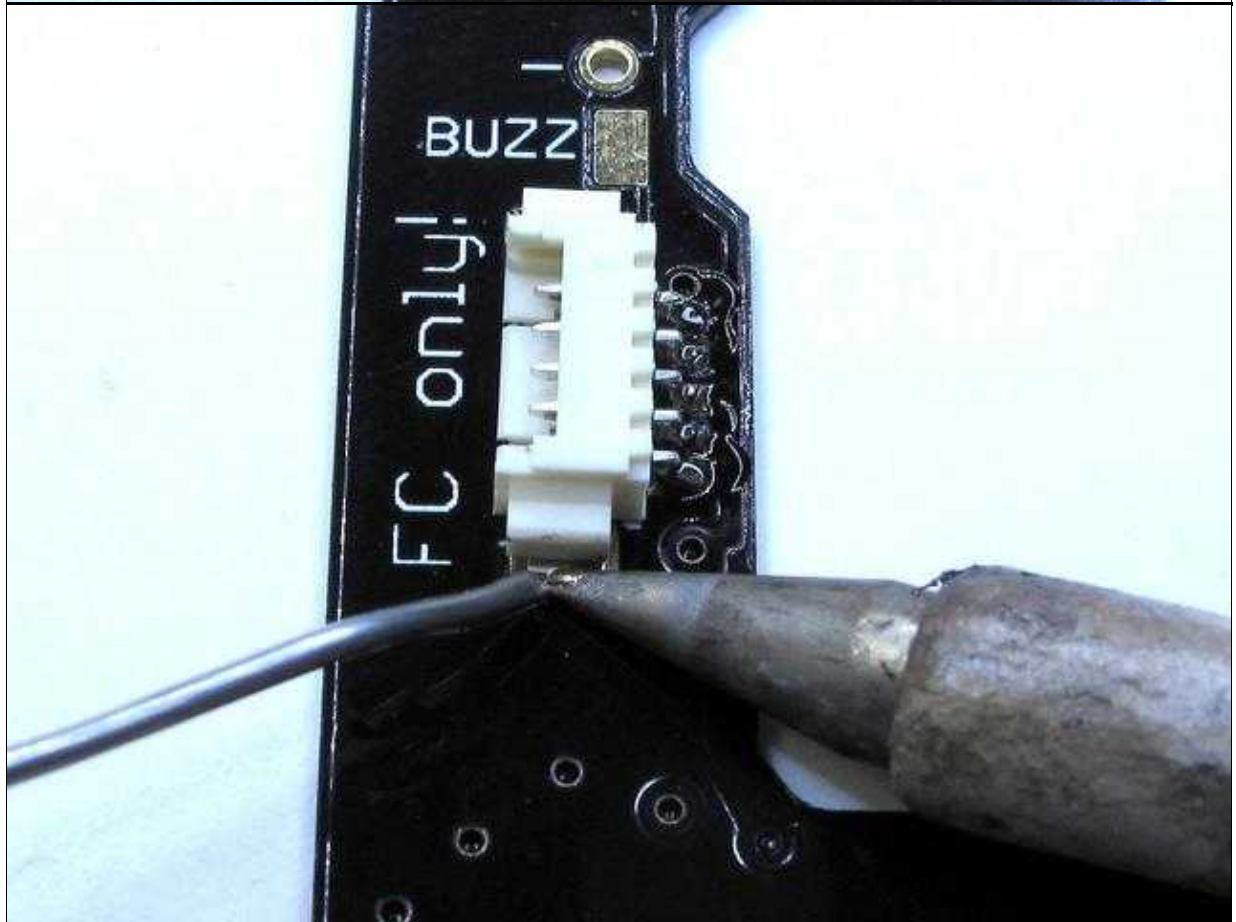
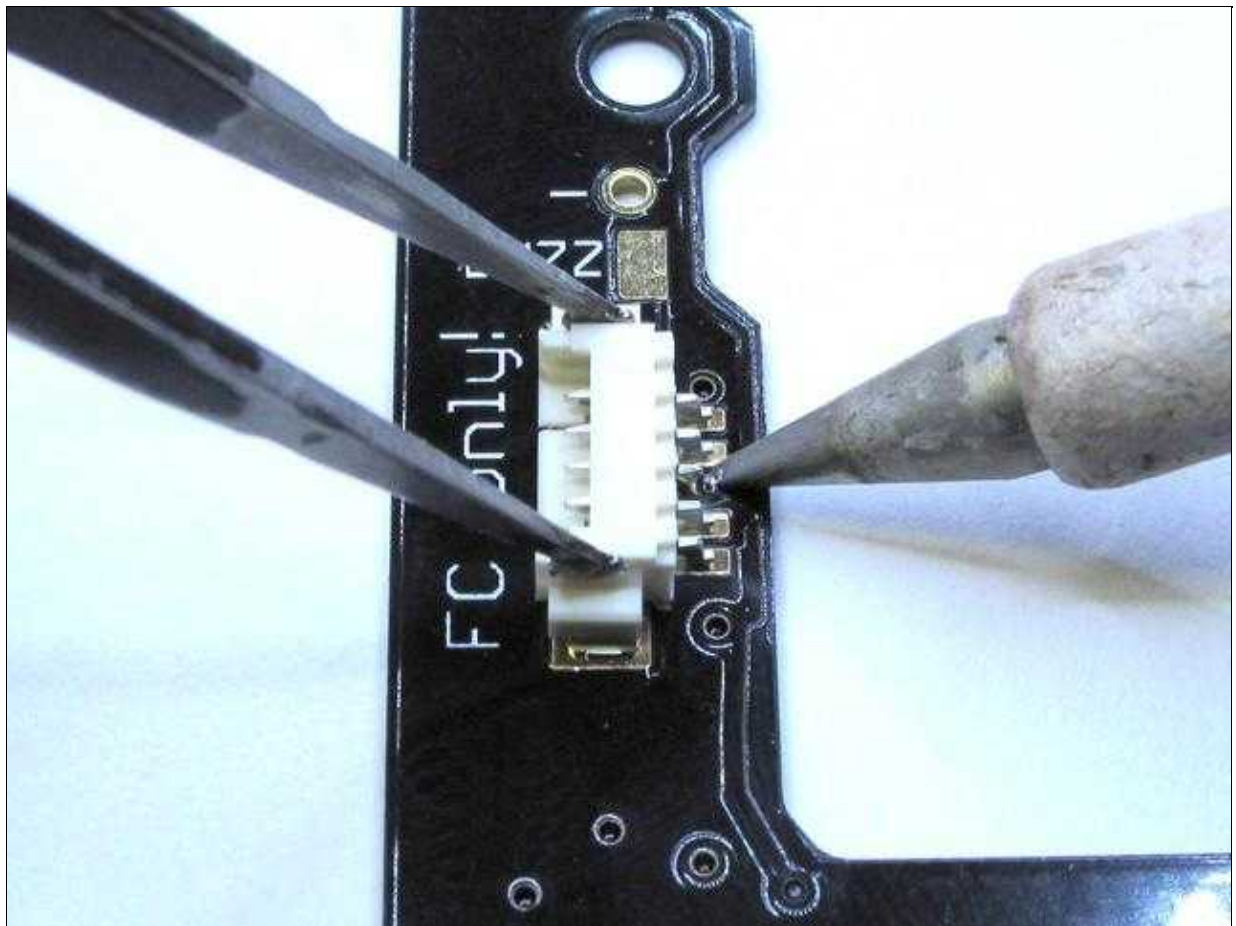

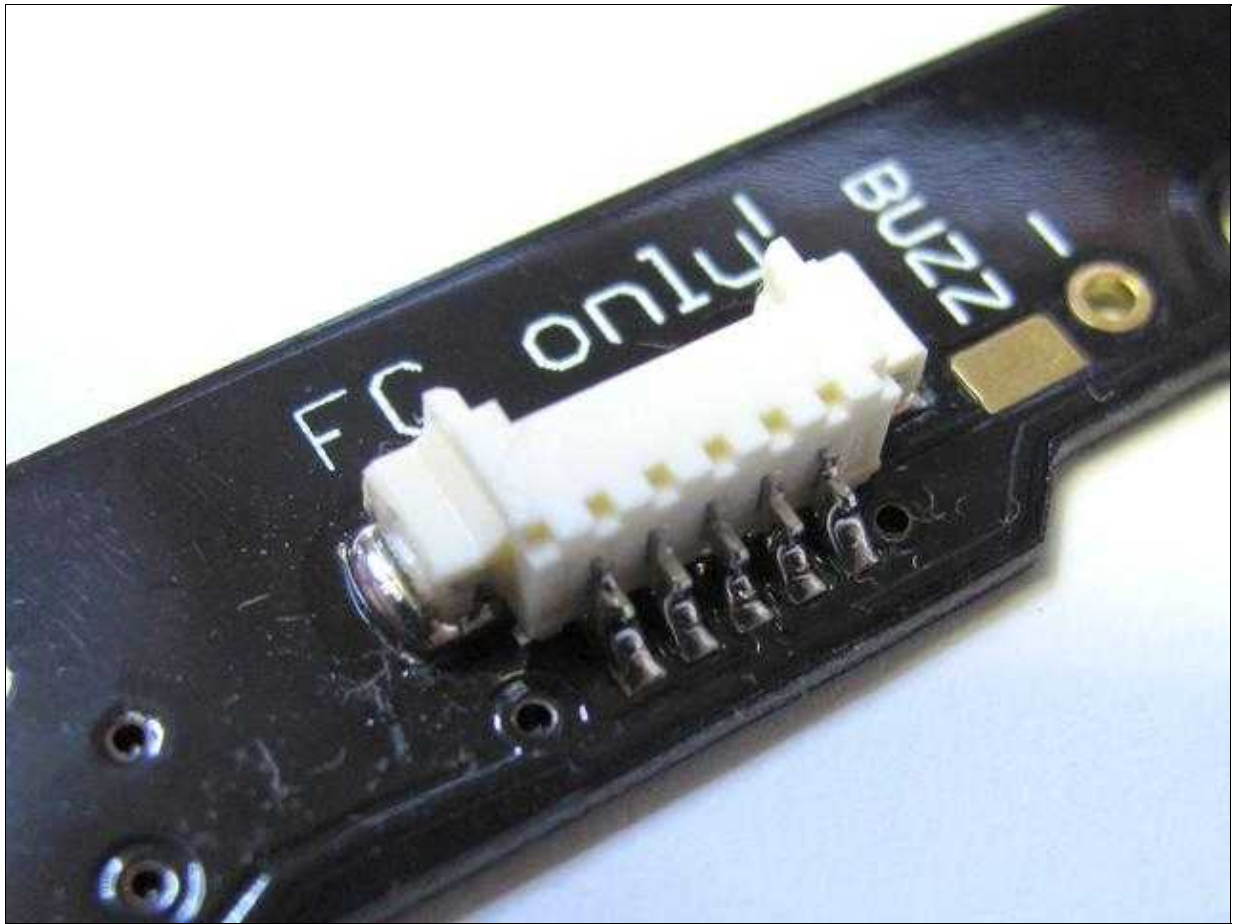

Solder heat conductor

To the OktoXL power distributor can soldered four heat conductors. These serve a better heat dissipation of the BL-Ctrl.

The heat conductors are soldered to the four designated areas on both sides.

 The boards can be very hot during soldering!

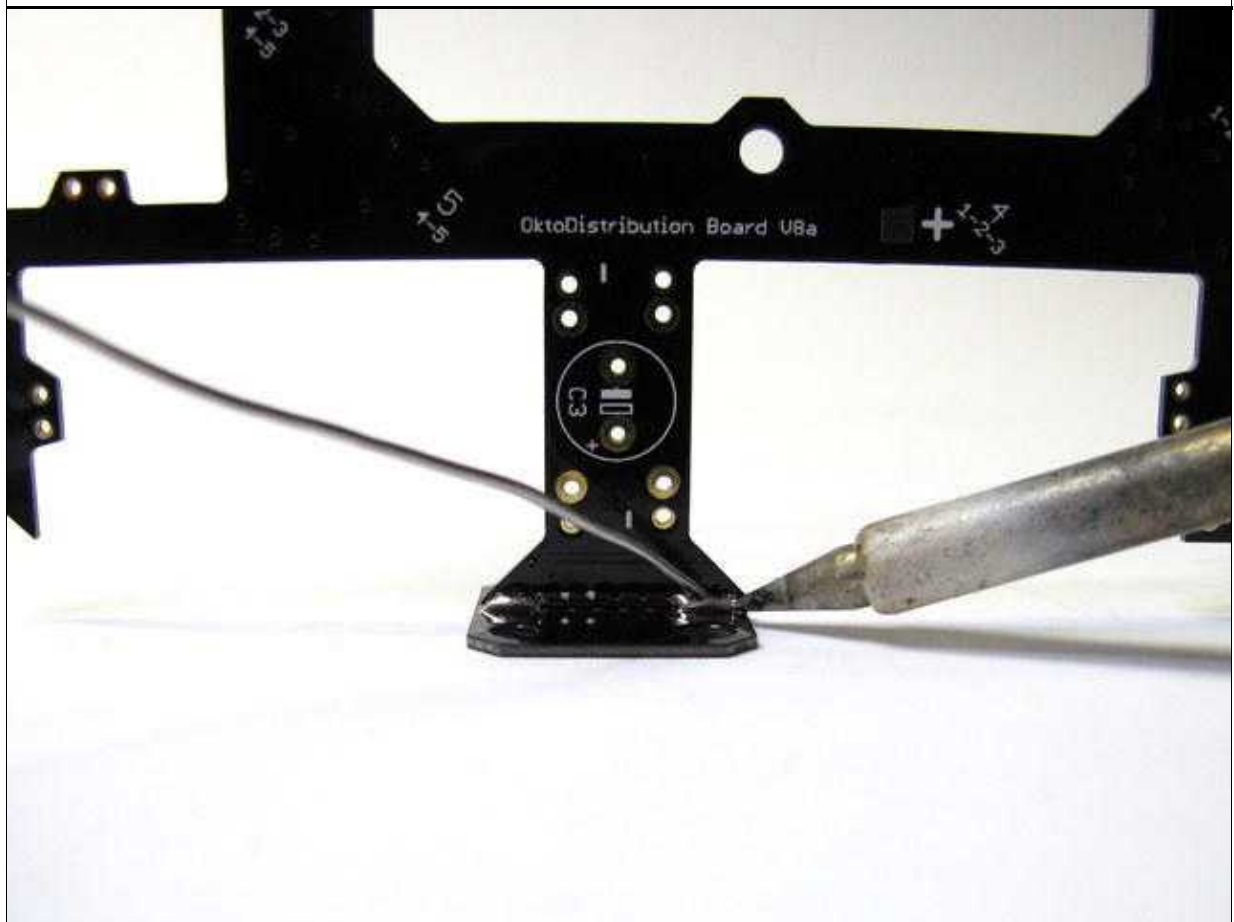
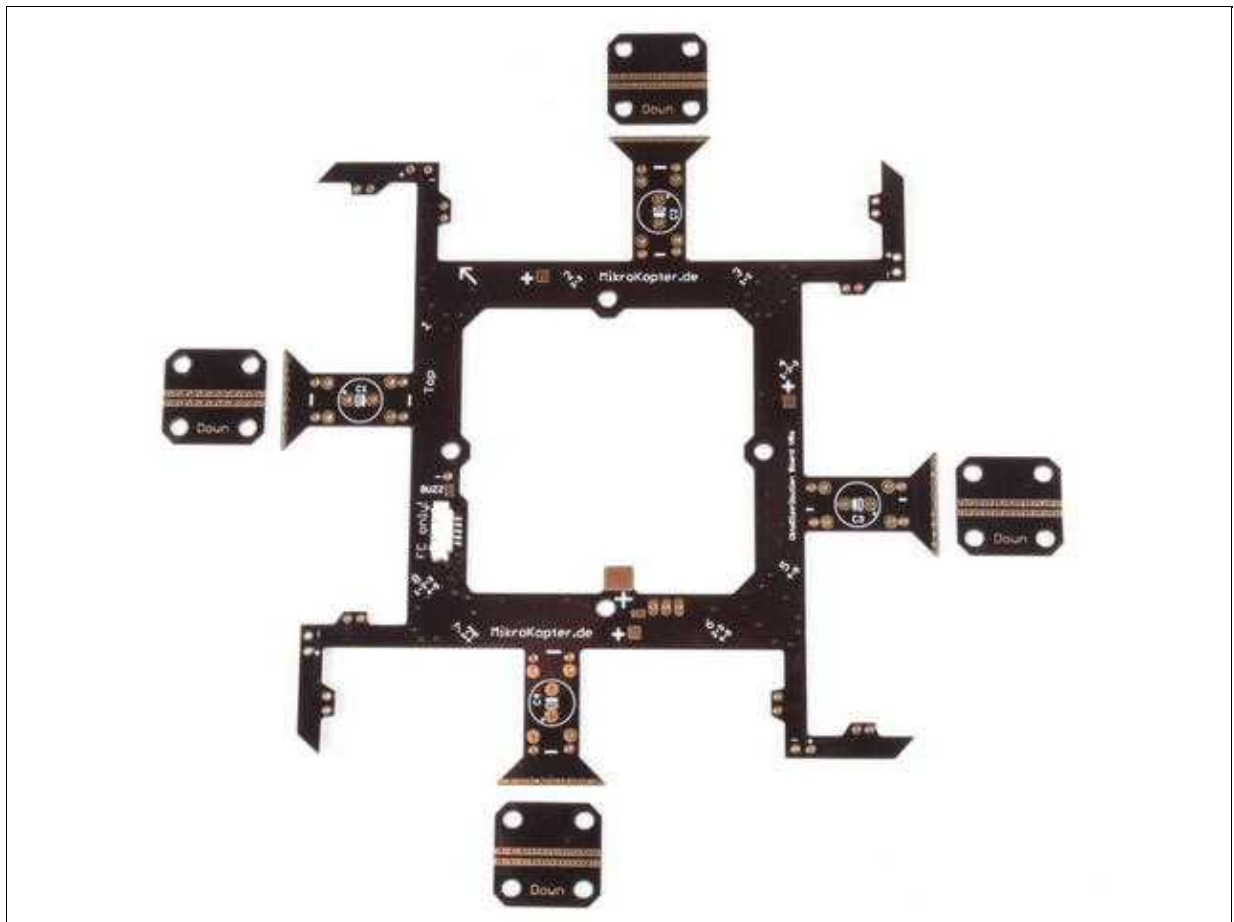

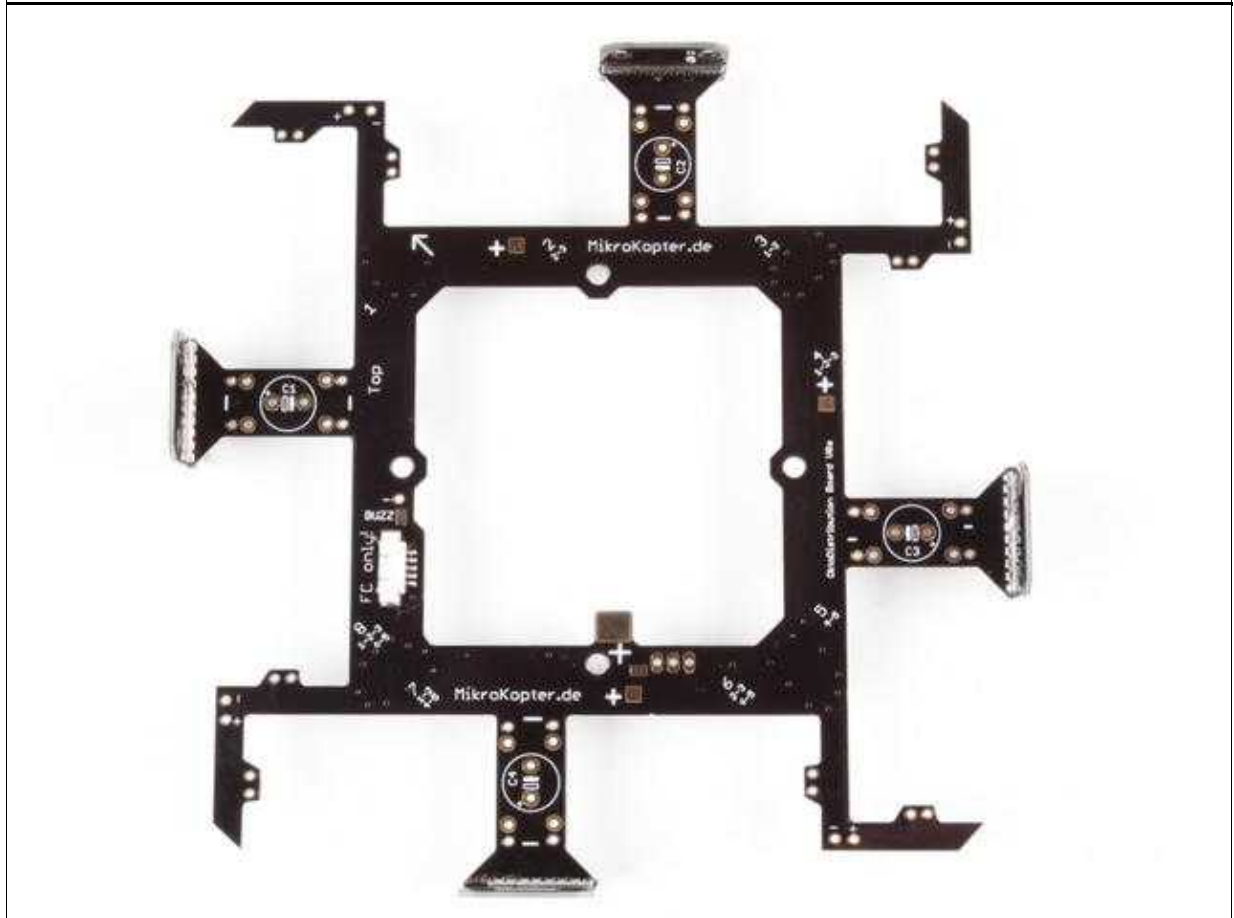

soldering the Capacitors on the BL-Ctrl2.0

All elkos can be mounted on the bottom on this current distribution.

The two elkos with the correct polarity to be first glued to the underside of the BL-Ctrl2.0, then soldered from the bottom.

The glue is made to ensure that the capacitors do not slip through vibrations in the air.



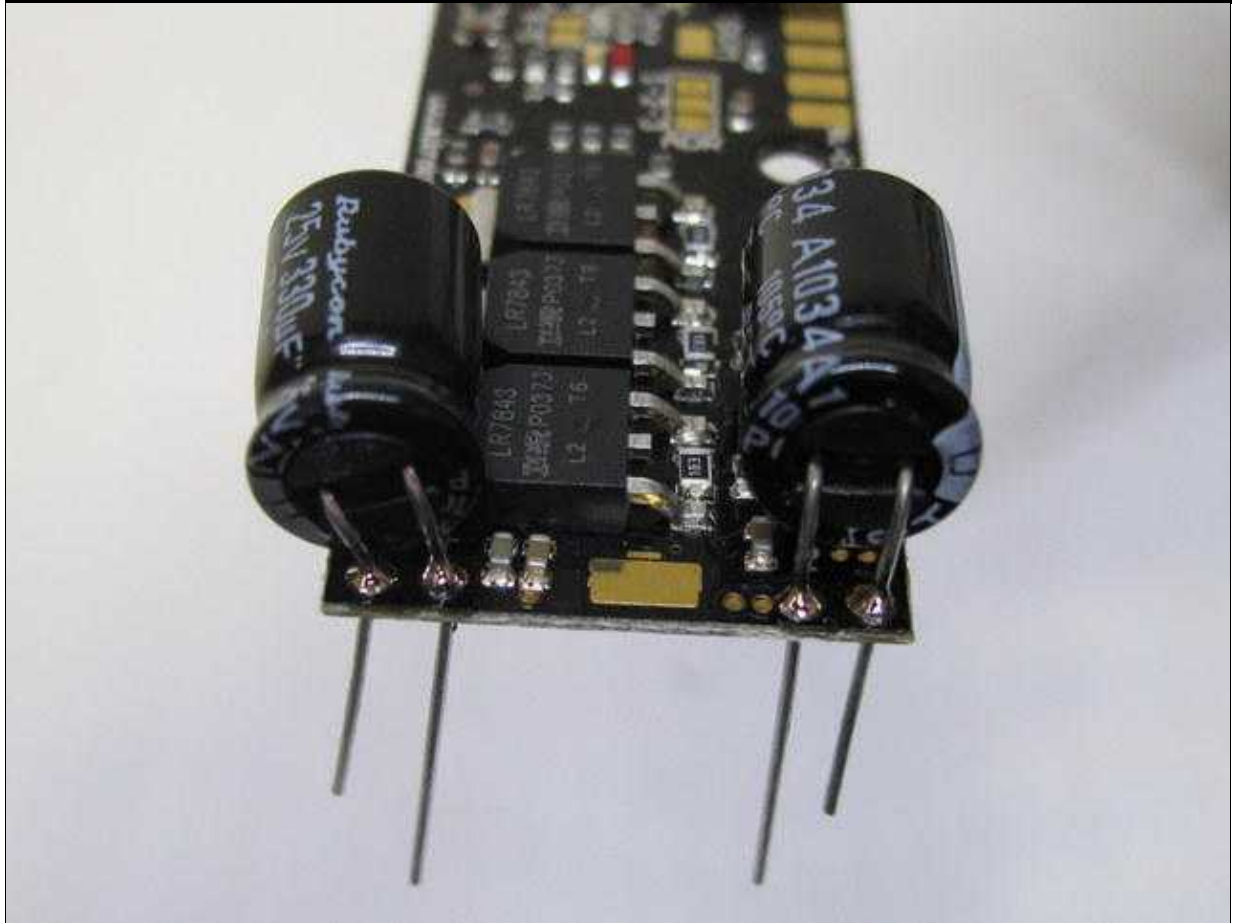
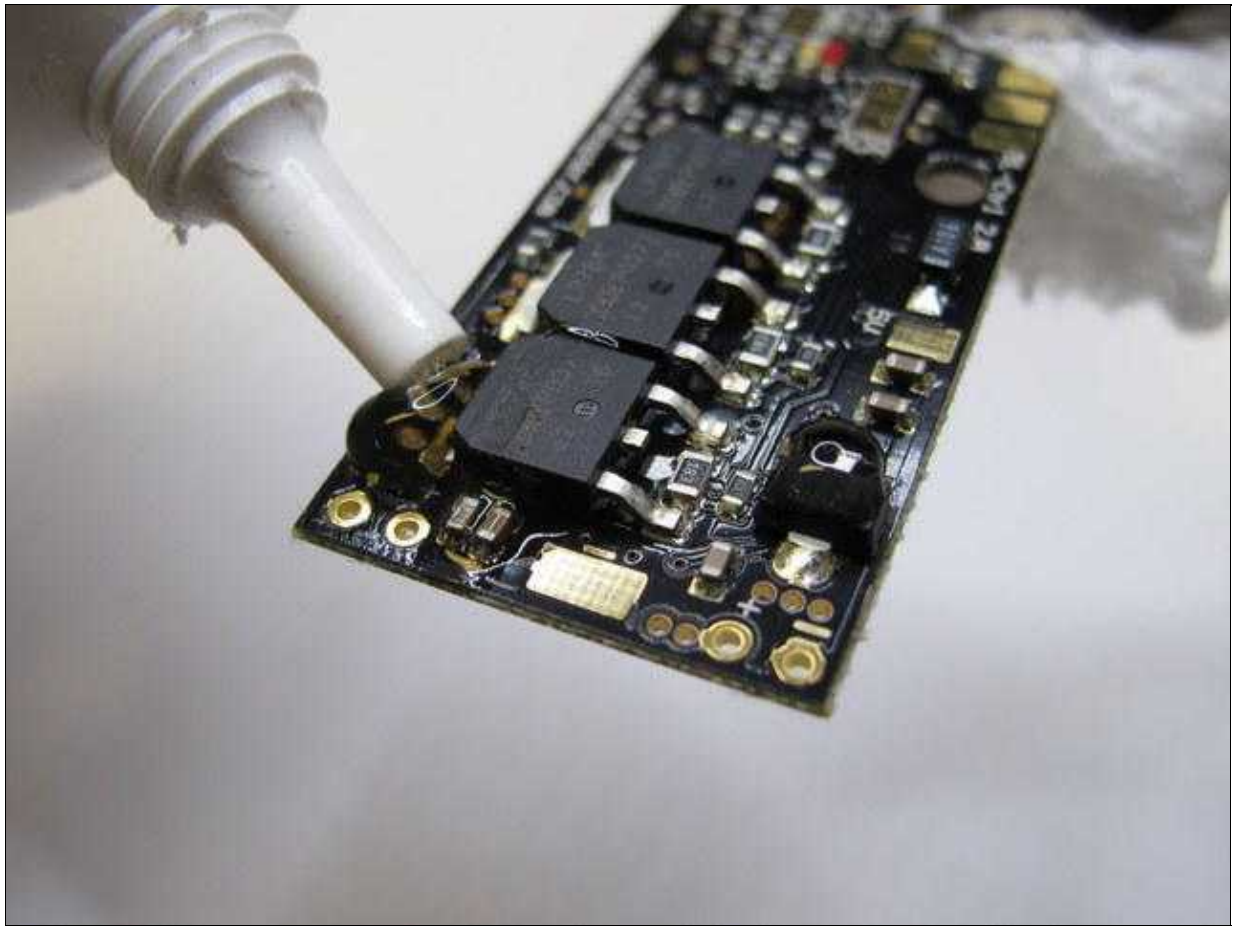

soldering the BL-Ctrl2.0 on the Power Distribution

Are the elkos on the BL-Ctrl2.0 soldered, the BL-Ctrl2.0 be inserted from the bottom of the current distributor in the connecting holes of the elkos.

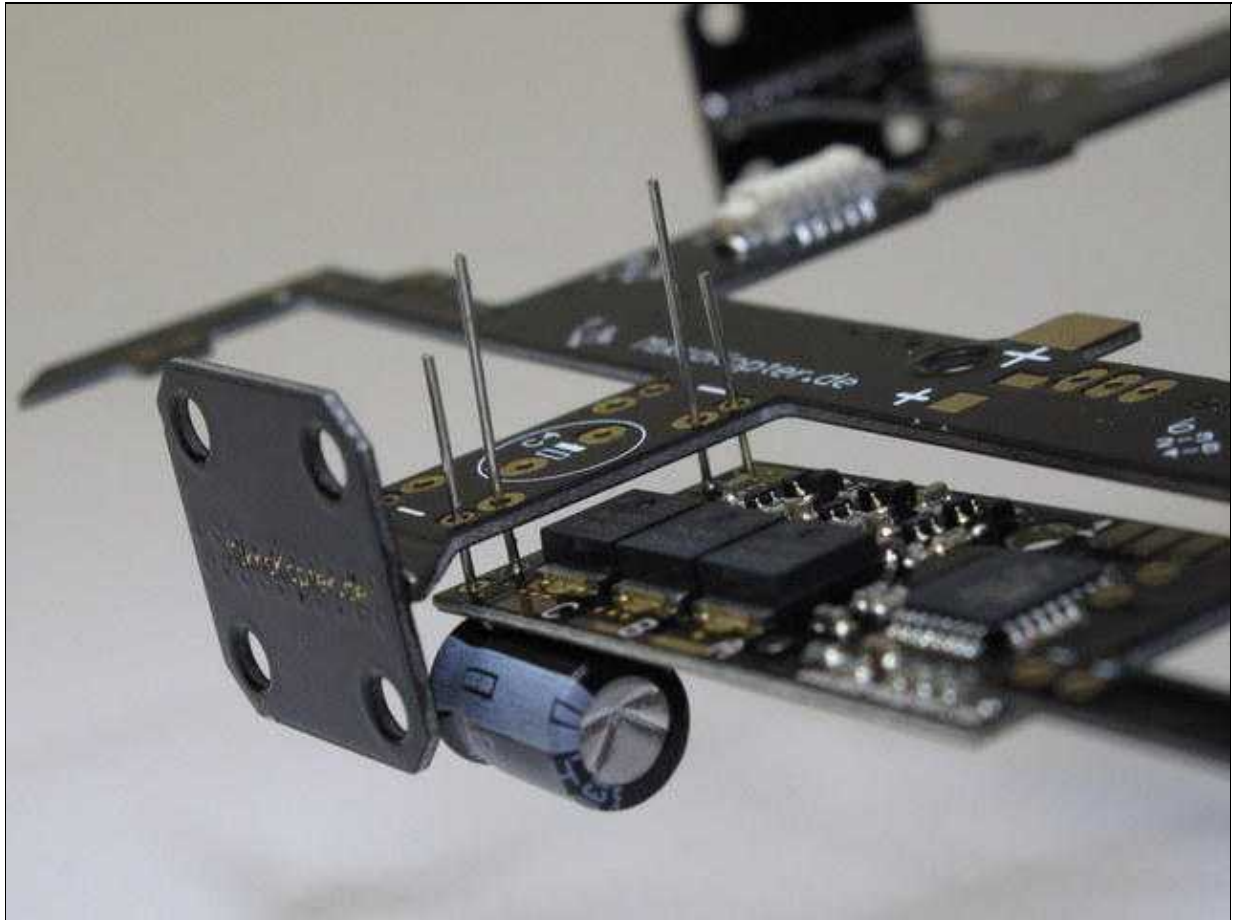

When soldering the capacitors and the I2C bus, take care that the BL-Ctrl2.0 applied directly to the power distributor.

This achieves the greatest possible heat dissipation.

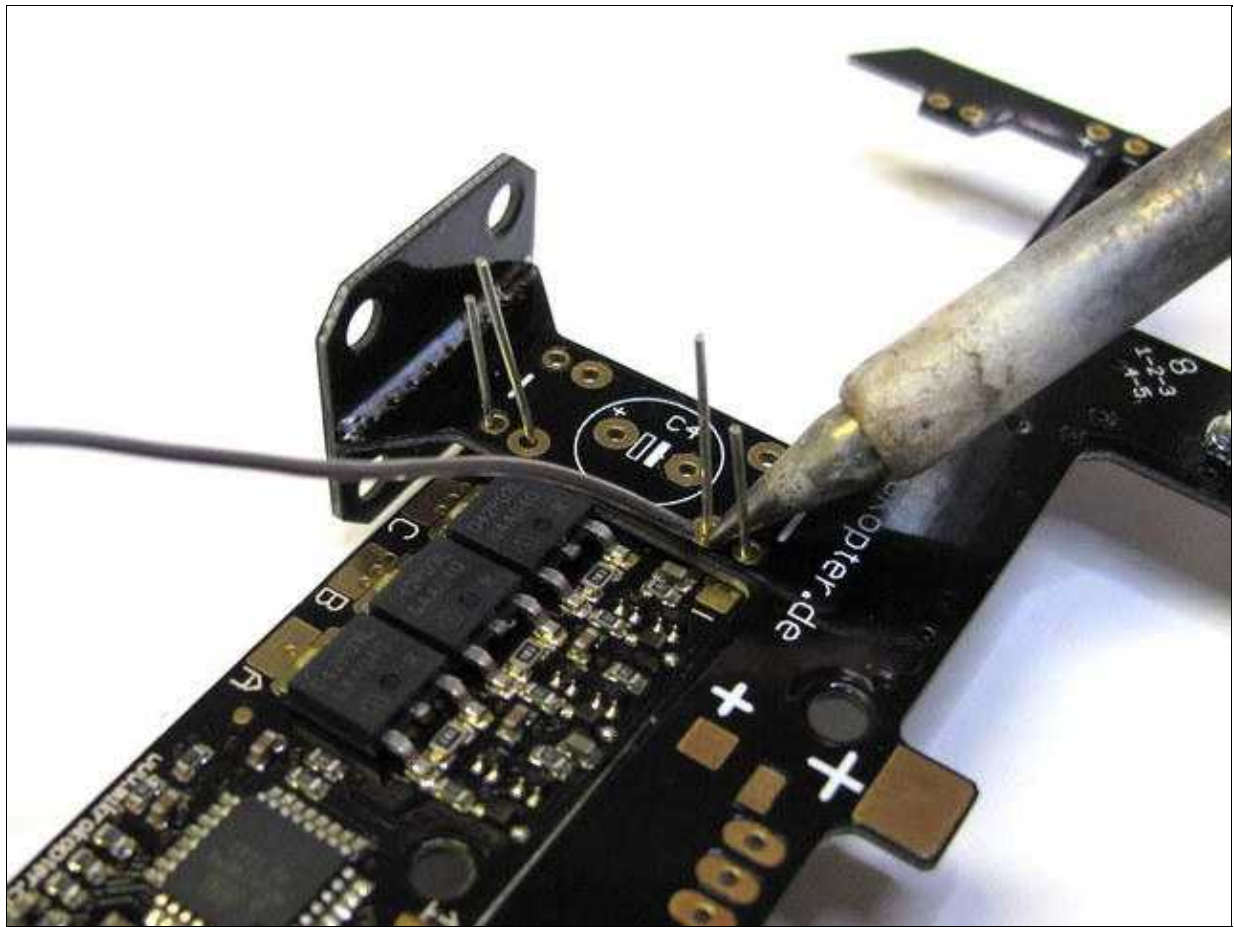

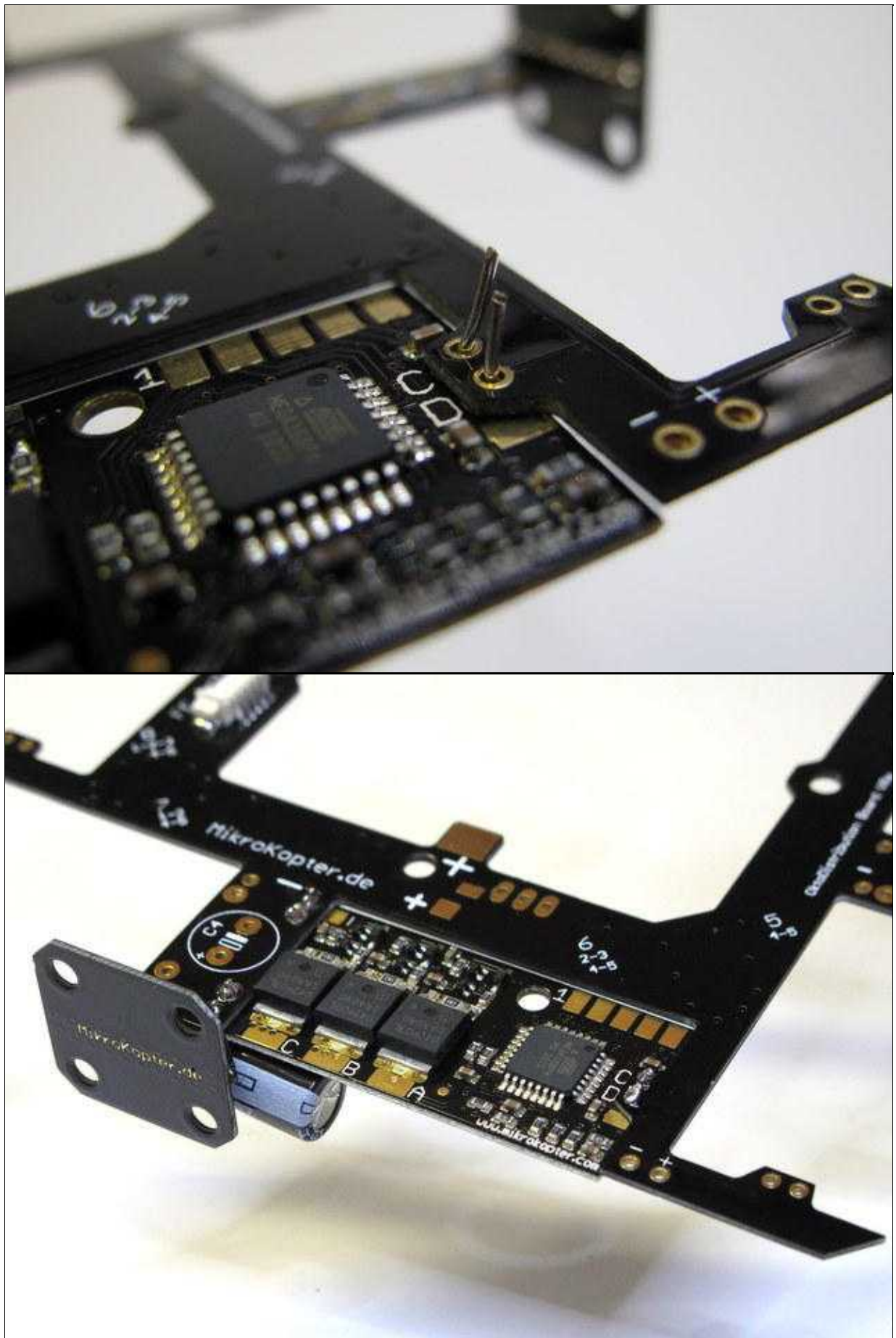

⚠ The board can be very hot during soldering

Address selection

Each BL-Ctrl requires now a unique address. Therefore, the BL controllers assign addresses. A Quadrokopter get the addresses 1-4, a [HexaKopter](#) the addresses 1-6 and a Oktokopter the addresses 1-8. On the power distributor each address is already printed.

On BL-Ctrl V2.0 the motor address is set on the board using jumpers (use solder).

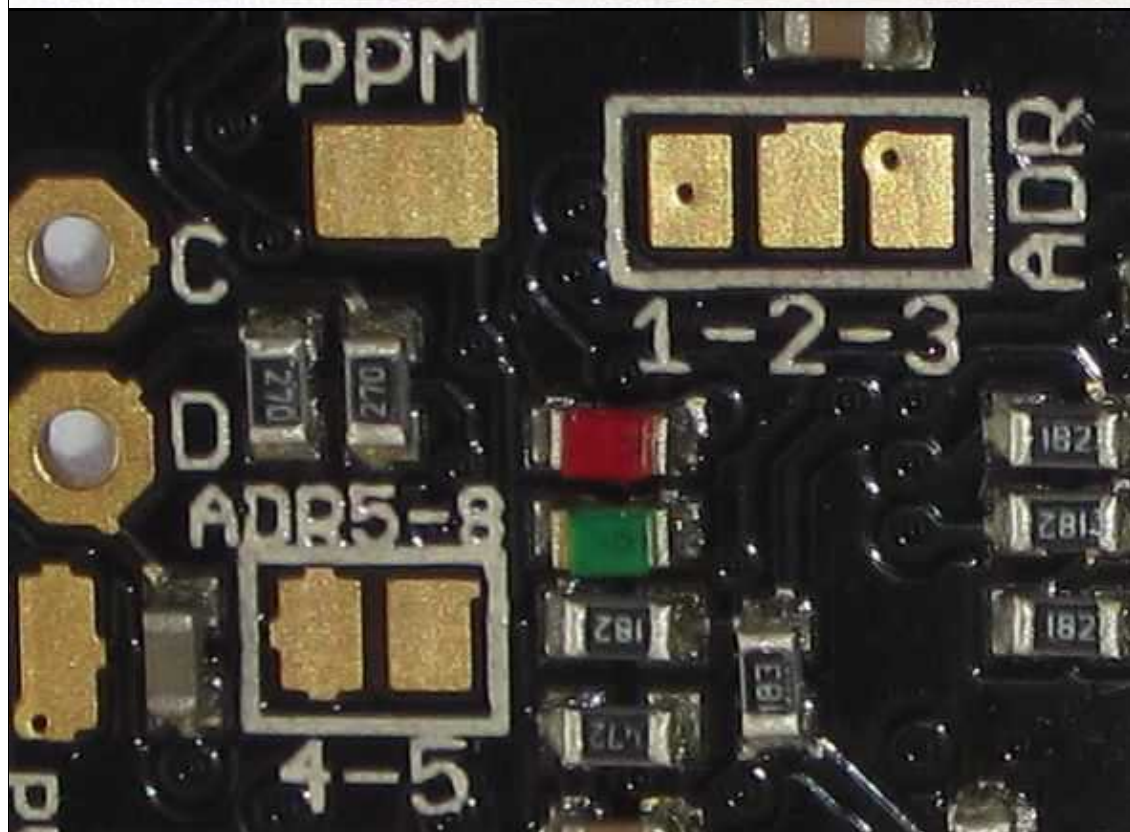
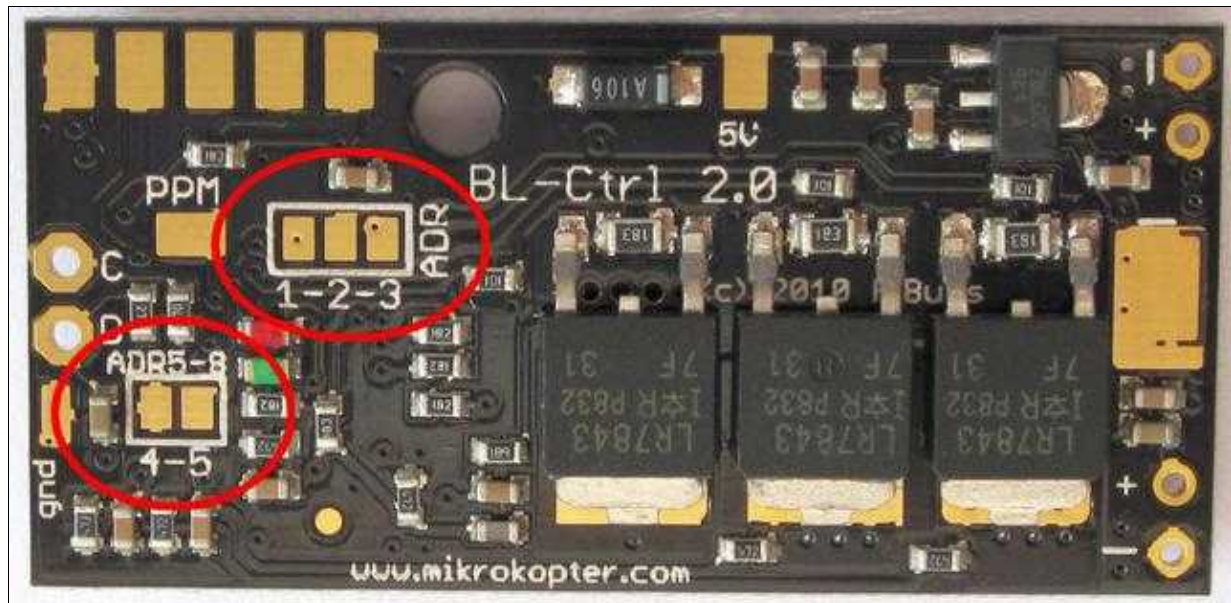

Where:

Adress (Motor)	1-2	2-3	4-5
1	open	open	open
2	open	closed	open
3	closed	open	open
4	closed	closed	open
5	open	open	closed
6	open	closed	closed
7	closed	open	closed
8	closed	closed	closed

 More information about the BL-Ctrl2.0 can be found here: [BL-Ctrl2.0](#)

Powerboard

Power Distributor - Top

.

Power Distributor - Bottom

Bottom view of the Okto XL V3 - Combi distribution board..

.

Supply

There is an already installed powercable on the distribution board.

.

Connect the Buzzer

 You can mount the buzzer on a rigger or with a [Buzzer Adapter board](#).

- If the buzzer would be to close to the compass, the compass readings could be disturbed!

Solder the Buzzer on the "Buzz"-Pad (+) and "-"-Pad.

- buzzer plus = red cable = "Buzz"
- buzzer GND = black cable = "- " = "minus"

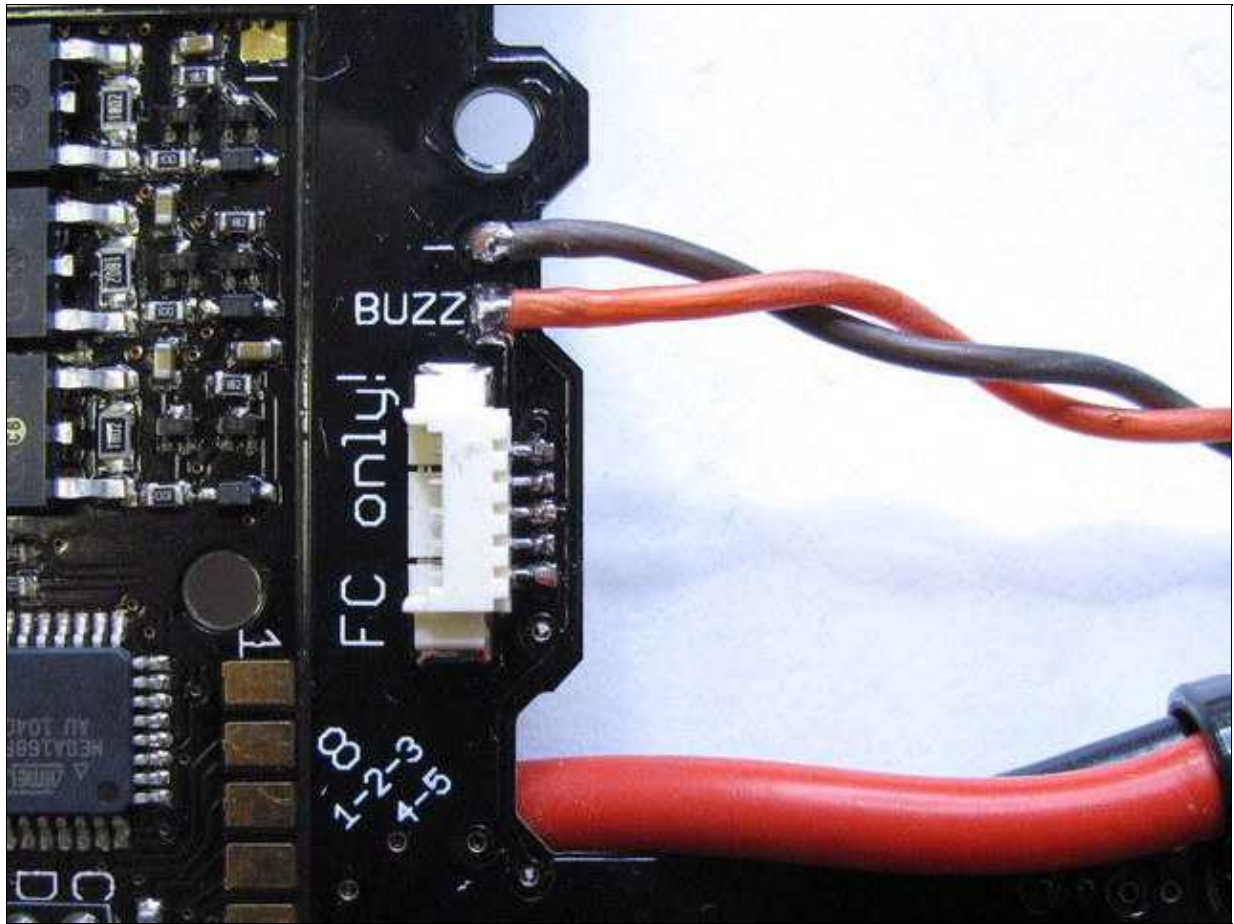

Lighting

You can connect the lighting (LED) directly to the outer "+" and "-" pad.

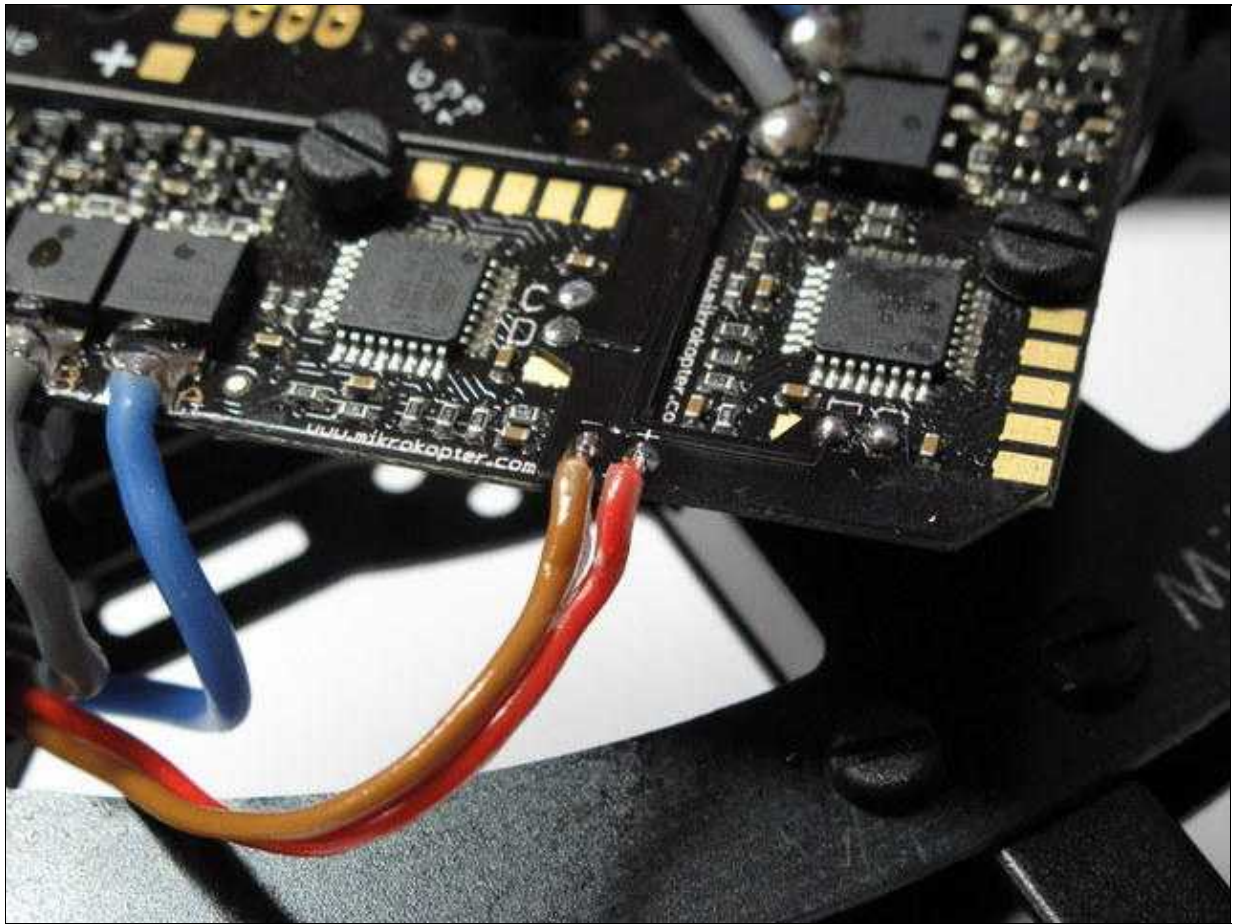

Connect the LED's like you see here:

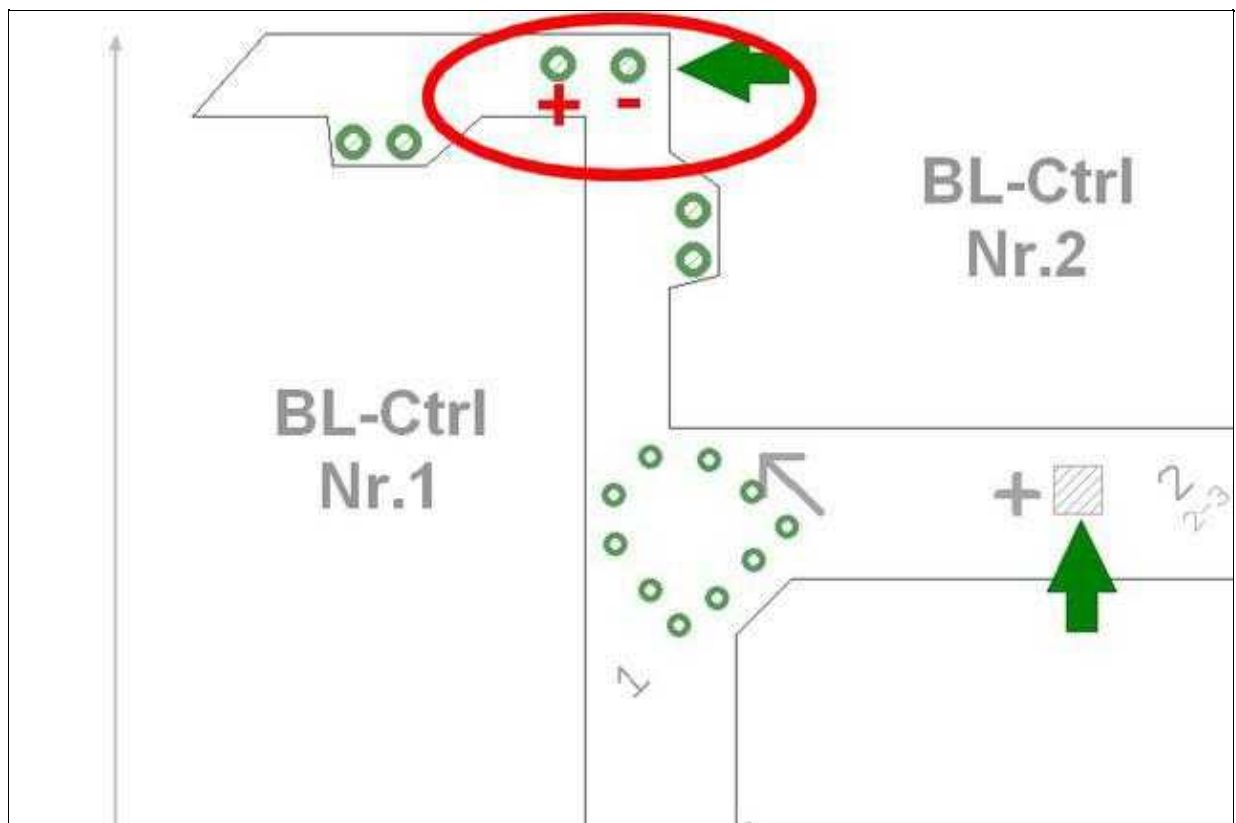

Lighting switchable

If you want to switch the lights, the optional ExtensionPCB can be used for this purpose. The connection is described here:: [ExtensionPCB](#)

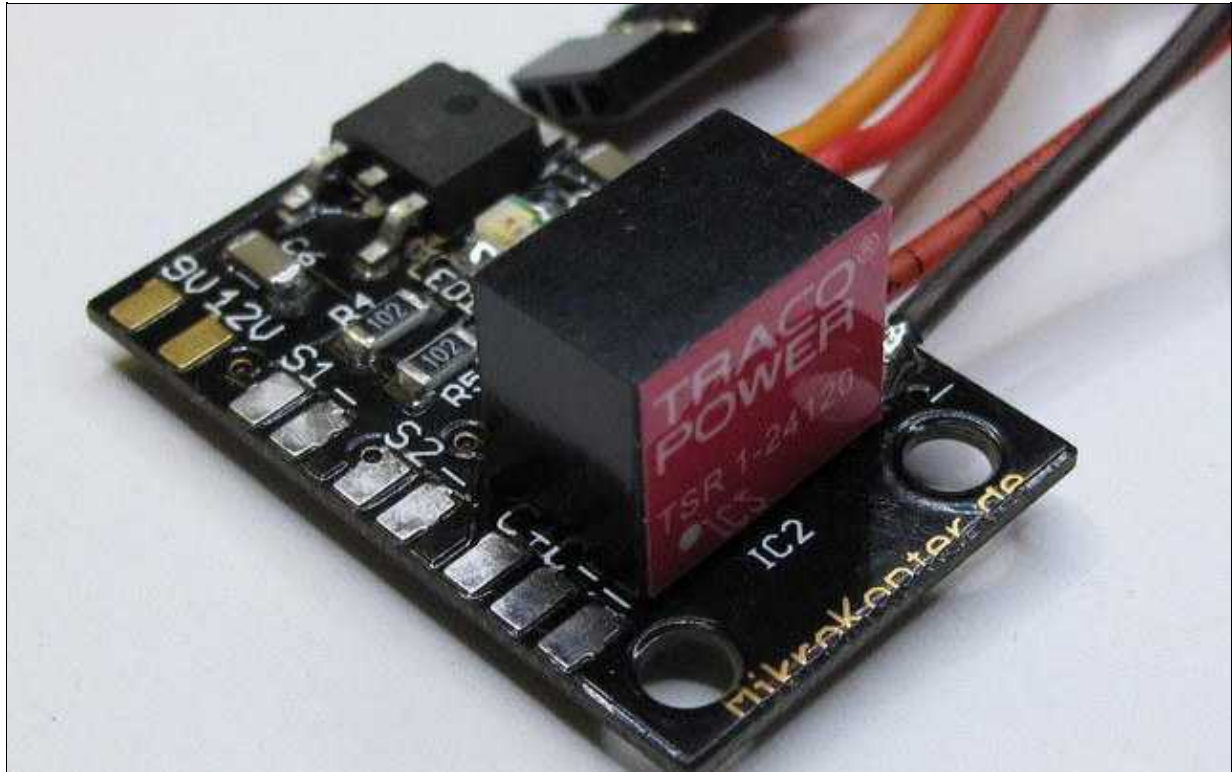

connect the FC

The [FlightCtrl2.1](#) will be connected later with the Molex-cable.

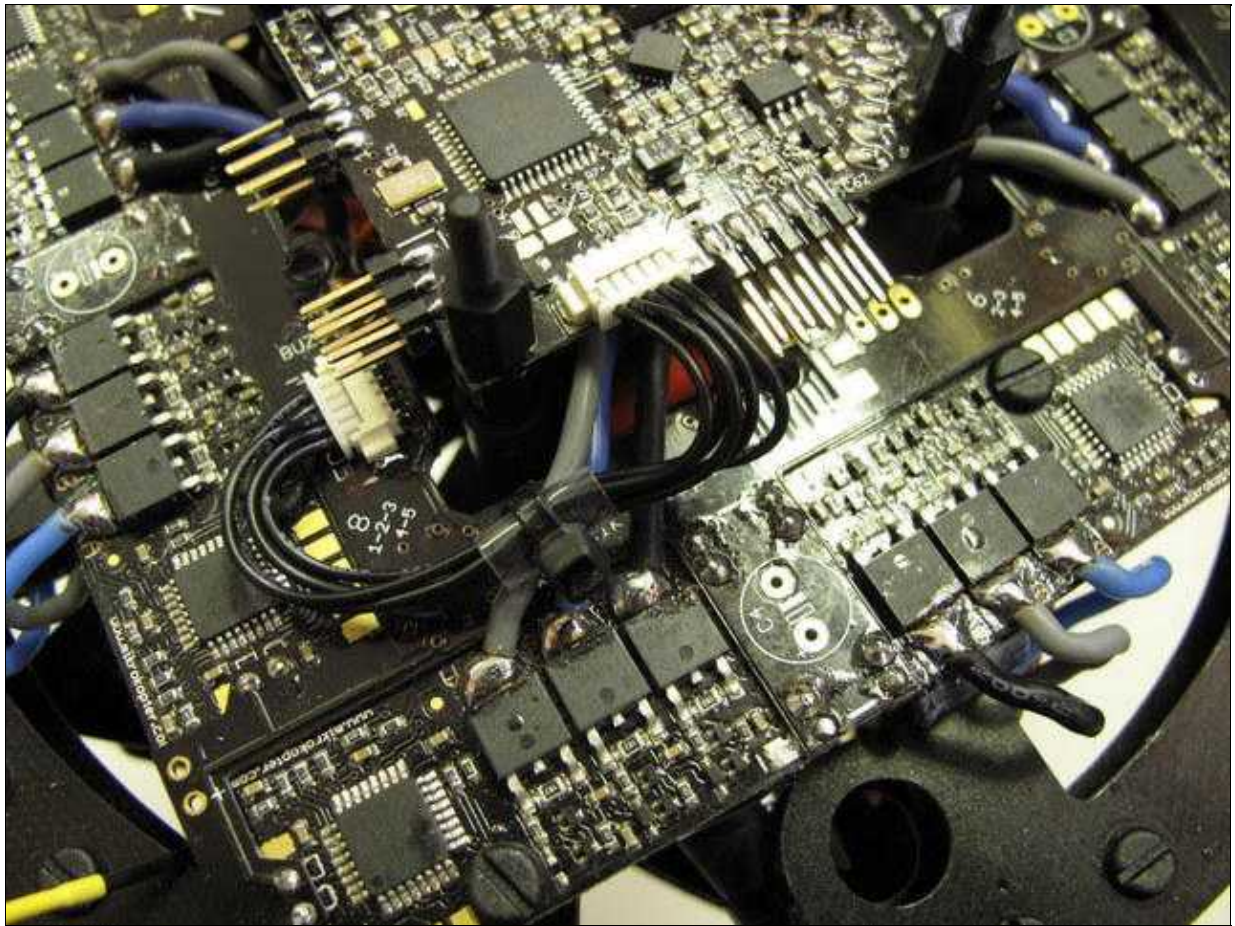

⚠ The printed arrow on the [FlightCtrl](#) must point to the on the rigger No.1 (red rigger) !